

DMD#19174

**ROLE OF HAPTOGLOBIN ON THE UPTAKE OF NATIVE AND
 β -CHAIN [TRIMESYL-(LYS82) β -(LYS82) β] CROSS-LINKED HUMAN
HEMOGLOBINS IN ISOLATED PERFUSED RAT LIVERS**

Edwin C.Y. Chow, Lichuan, Liu¹, Noam Ship, Ronald H. Kluger, and K. Sandy Pang

Departments of Pharmaceutical Sciences (ECYC, LL, KSP) and Chemistry (NS, RK),
University of Toronto, Canada

DMD#19174

Running Title: Haptoglobin on hemoglobin clearance in perfused rat liver

Correspondence: Dr. K. Sandy Pang

Faculty of Pharmacy, University of Toronto

144 College Street, Toronto, Ontario

Canada M5S 3M2

TEL: 416-978-6164

FAX: 416-978-8511

E-mail: ks.pang@utoronto.ca

Abstract: 249 words

Introduction: 735 words

Discussion: 1249 words

Table: 4

Figures: 6

References: 40

Glossary of Terms:

α	Hybrid constant associated with the distribution phase in compartmental modeling
β	Hybrid constant associated with the elimination phase in compartmental modeling
C_R , C_{EC} , and C_L	Concentrations of hemoglobin in reservoir, extracellular plasma, and liver compartments, respectively
CL	Hepatic clearance
CL_{influx} and CL_{efflux}	Influx and efflux clearances, respectively, at the sinusoidal membrane
$CL_{int,met}$	Hepatic metabolic intrinsic clearance
k_{12}	Micro rate constant denoting entry from central compartment to peripheral compartment
k_{21}	Micro rate constant denoting entry from peripheral compartment to central compartment
k_{20}	Micro rate constant denoting elimination from peripheral compartment
Hp	Haptoglobin
HB	Hemoglobin
KHB	Krebs Henseleit bicarbonate buffer
Q	Total hepatic flow rate
$t_{1/2, \beta}$	Elimination half life of the beta phase
V_R , V_{EC} , and V_L	Volumes of reservoir, extracellular plasma, liver, respectively

DMD#19174

ABSTRACT

The role of haptoglobin in liver cell entry of acellular native hemoglobin, and cross-linked human hemoglobin, a potentially useful oxygen-carrier alternative in transfusion medicine, was examined in the recirculating, perfused rat liver preparation. Doses of tritiated native human or β -chain [trimesyl-(Lys82) β -(Lys82) β] cross-linked human hemoglobin were pre-incubated with haptoglobin-containing rat plasma or Krebs Henseleit bicarbonate buffer (KHB) for 30 min and used for perfusion. Concentrations (dpm/ml) in reservoir, before and after separation of the hemoglobins and metabolites by Gel Filtration FPLC column chromatography, were similar, showing mostly the presence of intact hemoglobin. Each hemoglobin species underwent a rapid distribution phase, followed by a protracted elimination phase. The radioactivity in bile at 3 h comprised of low molecular weight metabolites, and cumulative excretion was slightly higher when rat plasma was present: for native hemoglobin, $7.1 \pm 1.6\%$ vs. $9.2 \pm 2.1\%$ dose; for cross-linked hemoglobin, $5.0 \pm 1.7\%$ vs. $7.2 \pm 0.8\%$ dose. Data fit to a two-compartment model and physiologically-based model revealed a significantly faster influx clearance (CL_{influx}) over the metabolic intrinsic clearance ($CL_{int,met}$). The ratios of $CL_{influx}/CL_{int,met}$ were 125 and 535 for native hemoglobin in absence and presence of rat haptoglobin, respectively, according to compartmental analyses; the ratios were 25 and 53, respectively, according to physiological modeling. The corresponding ratios for cross-linked hemoglobin in absence and presence of rat haptoglobin were 55 and 81, respectively, and 24 and 70 for compartmental and physiological modeling. Although haptoglobin enhanced the hepatic internalization of the hemoglobins, the impact on the net clearance was lessened since degradation was the rate-limiting step.

DMD#19174

INTRODUCTION

Hemoglobin is a tetrameric heme protein that is found within red blood cells. This protein is comprised of a pair of $\alpha\beta$ dimers to form its tetrameric structure (Greer et al., 1981; Voet and Voet, 1995; Chang, 1999). In the tetrameric format, hemoglobin plays an important role in the binding to oxygen and the supply of oxygenated blood to tissues and organs (for review, see Winslow, 1992). During intravascular hemolysis, hemoglobin is released from the red blood cells and distributes into the plasma where free hemoglobin (HB) is rapidly bound to haptoglobin (Hp), a specific plasma binding protein of high affinity ($K_d \approx 1 \times 10^{-15}$ M) towards the alpha chain on the hemoglobin (Putnam, 1976; McCormick and Atassi, 1990; Lim et al., 1998). The complex is then taken up by an unknown receptor on hepatocytes and by the CD 163 hemoglobin scavenger receptor on macrophages that are present in the spleen, thymus, Kupffer cells, and bone marrow (Graversen et al., 2002; Polfliet et al. 2006).

In cases of transfusion of acellular hemoglobin or severe hemolysis, high levels of hemoglobin are present that will easily saturate the haptoglobin present in plasma (Keene and Jandl, 1965; Hershko et al., 1972). Excess hemoglobin in plasma exists in the form of its constituent $\alpha\beta$ -dimers that are removed primarily by renal filtration, a mode of elimination that results in iron deposit in the renal tubules than can lead to renal damage (Chang, 1999; Gburek et al., 2002; Roach et al., 2004). Due to the large molecular size, the bound hemoglobin-haptoglobin complex is protected from renal excretion (Keene and Jandl, 1965). The complex is mainly eliminated through the liver (Bissell et al., 1972; Hershko et al., 1972; Goldfischer et al., 1970; Ship et al., 2005) by binding to receptors on the surface of hepatocytes for endocytosis (Bissell et al., 1972; Kino et al., 1980, 1987; Zuwala-Jagiello and Osada, 1998). Hepatic elimination is the primary process for the clearance of acellular hemoglobin, and hepatocyte uptake may occur by a haptoglobin-independent pathway (Hershko et al, 1972; Weinstein and

DMD#19174

Segal, 1984). The internalized hemoglobin is then metabolized in lysosomes (Graversen et al., 2002), generating hemoglobin metabolites such as bilirubin, globin chains, and iron bound to transferrin (Goldfischer et al., 1970; Hershko et al., 1972; Higa et al., 1981). Bilirubin is then further glucuronidated by UDP-glucuronosyltransferase 1A1 (UGT1A1) and excreted into bile while the iron transferrin and globin chains are returned back to the plasma (Clarke et al., 1997; Huang et al., 2004).

Aspects of the processes of blood transfusion have stimulated research towards the development of red cell substitutes (Creteur and Vincent, 2003). Acellular hemoglobin, a tetrameric protein, rapidly dissociates into its constituent $\alpha\beta$ -dimers that are subsequently cleared by filtration in the kidney (Bunn et al., 1969). It is therefore associated with short circulation times (1 to 4 h) and kidney toxicity, precluding its usefulness (Roach et al., 2004). Chemically cross-linked hemoglobins that prevent the dissociation to dimers tend to exhibit prolonged circulation times (Palaparthi et al., 2001). Formation of the hemoglobin-haptoglobin complex results in liver clearance (Bissell et al., 1972; Kino et al., 1980; Zuwala-Jagiello and Osada, 1998), fueling the postulate that haptoglobin binding of synthetically prepared hemoglobins may result in increased hepatic internalization and faster clearance. Indeed, Ship et al. (2005) found a correlation between binding and clearance. The lower *in vitro* binding of β -chain [trimesyl-(Lys82) β -(Lys82) β] cross-linked human hemoglobin to rat haptoglobin (~30% bound) resulted in a lower distribution, and reduced plasma clearance, and biliary excretion when compared to native human hemoglobin, which is almost completely bound (100%) in rats *in vivo*. Both native human hemoglobin and β -chain [trimesyl-(Lys82) β -(Lys82) β] cross-linked human hemoglobin exhibited short half lives (23 to 37 min) (Ship et al. 2005).

The contribution of the liver, in the absence of other eliminating organs such as the kidneys, to the removal of hemoglobin is unknown. The hepatic handling of hemoglobin vs. the

DMD#19174

[trimesyl-(Lys82) β -(Lys82) β] cross-linked human hemoglobin has not been directly compared. In the present recirculating liver perfusion study, we tested the hypothesis that haptoglobin binding to hemoglobin plays a role in enhancing hepatic internalization and clearance of native human hemoglobin and β -chain [trimesyl-(Lys82) β -(Lys82) β] cross-linked human hemoglobin. Trace amounts of the radiolabeled hemoglobins were administered in buffer in the presence or absence of rat plasma haptoglobin for hemoglobin binding in liver perfusion studies. This condition ensured that haptoglobin, when present, was in excess in relation to hemoglobin to ensure maximum binding (Ship et al., 2005).

DMD#19174

METHODS

Materials

Radiolabeled [1-³H]acetic anhydride (50 mCi/mmol) was purchased from American Radiolabeled Chemicals (St. Louis, MO). Bovine serum albumin in Tyrode's solution was supplied by Sigma Aldrich, Canada (Mississauga, ON), and dextrose (50% injection USP) was obtained from Abbott Laboratories (Montreal, QC). Dextran T-40 was purchased from Amersham Biosciences (Québec, QC). Human hemoglobin was purified from pooled red cells provided by Hemosol Inc. (Mississauga, ON) and stored liganded to carbon monoxide. The oxygen binding curves and metHb content was determined for each batch and the hemoglobin was found to be active and cooperative. All other reagents were of the highest available grade.

Synthesis of Radiolabel Human Hemoglobin and Human Hemoglobin Cross-linked with Trimesoyl Tris(3,5-Dibromosalicylate)

β -Chain [trimesyl-(Lys82) β -(Lys82) β] cross-linked human hemoglobin was prepared according to Kluger et al. (1992) and described previously (Ship et al., 2005). Carbon-monoxide-liganded hemoglobin (2 ml, 4 mM) was exposed to bright-white light and bubbled with oxygen (Bocs Gas) for 2 h at 0°C to exchange the carbon monoxide with oxygen. After gel chromatography, hemoglobin was deoxygenated with nitrogen at 37°C for 2 h before the cross-linking at the two β -Lys82 residues with a twofold excess of trimesoyl tris(3',5'-dibromosalicylate) (16 μ mol or 16 mg) for 16 h at 37°C (Kluger et al., 1992). The cross-linking reaction was stopped by bubbling oxygen to the reaction mixture. The tetrameric hemoglobin product was separated from unreacted trimesoyl tris(3',5'-dibromosalicylate) by size-exclusion chromatography and stored at 4°C under carbon monoxide (Ship et al., 2005). The purity of the cross-linked hemoglobin was >99% according to High Pressure Liquid Chromatography (HPLC)

DMD#19174

and previously described methodology (Kluger et al., 1992). Absence of monomeric β -chains was demonstrated by matrix-assisted laser desorption/ionization time-of-flight mass spectroscopy using an Applied Systems Voyager DE STR equipped with a 337-nm nitrogen laser. The concentration of hemoglobin was determined by the absorbance of cyanmethemoglobin in the sample prepared by reaction with potassium ferricyanide. Procedures similar to those of Ship et al. (2005) were followed for the radiolabeling of hemoglobin and cross-linked human hemoglobin by acetylation with [1-³H]acetic anhydride.

Recirculating Liver Perfusion Studies

Male Sprague-Dawley rats (320 ± 18 g) were obtained from Charles River (St. Constant, QC, Canada). The protocols were approved by the University of Toronto Animal Care Committee. Rats were given water and food *ad libitum* and kept under a 12:12-h dark-light cycle. [³H]Radiolabeled native or cross-linked human hemoglobin (20-100 nmol) was pre-incubated with either Krebs Henseleit bicarbonate buffer (KHB) or rat plasma, in a ratio of (1:25 mol:mol) for hemoglobin to haptoglobin, for 30 min at 37 °C; the haptoglobin concentration in rat plasma was determined in vitro by titration with rat hemoglobin (Bunn, 1967), and this was found to be ~1 mg/ml.

Liver Perfusion. The surgical procedure and TWO-TEN Perfuser (perfusion apparatus) had been described in detail previously; perfusate consisted of KHB that was oxygenated with 95% O₂ and 5% CO₂ (Bocs gases, Mississauga, ON) at 1 l/min (Tirona et al., 1999). Erythrocyte-free perfusate was prepared by mixing the hemoglobin doses with 150 ml of 1% BSA and 3% Dextran T-40, in KHB. After induction of anesthesia by intraperitoneal injection of a mixture of ketamine (90 mg/kg) and xylazine (10 mg/kg), the abdomen was opened with a V-section. The hepatic artery was ligated, and the portal vein and the bile duct were cannulated by a 14G needle double catheter and PE50 tubing, respectively. The rat liver was removed from the carcass and

DMD#19174

placed onto a home-built glass perfusion tray. The hepatic vein was not cannulated, and the venous perfusate outflow was allowed to drain directly into the reservoir. KHB perfusate recirculated the liver at a flow rate of 35-40 ml/min at 37 °C for 20 min for equilibration. Then KHB perfusate (usually 150 ml), containing the designated dose from a second reservoir, was used for continued recirculation for 3 h. The reservoir perfusate (1 ml) was sampled at 0, 3.5, 10, 20, 30, 45, 60, 75, 90, 120, and 180 min, whereas bile was collected at 30 min intervals. At the end of the experiment (180 min), the liver was flushed with ice-cold, blank KHB to remove any residual blood. The liver was weighed, added KHB (1:2.5 v/v), homogenized by the Ultra-Turrex T25 homogenizer (Janke and Kunkel, Germany), and stored at -20°C until further analysis. Reservoir perfusate data were expressed in terms of concentrations and amounts (concentration x volume of reservoir), normalized to dose; for bile, the cumulative amounts in bile, normalized to dose, were presented.

Sample Analyses. The disappearance of the radiolabeled hemoglobin species in buffer perfusate and the appearance of hemoglobin metabolites in bile were studied by column chromatography of the samples. Perfusate and bile samples were applied to a Superdex G-75 size-exclusion column, eluting with 0.1 M phosphate buffer, pH 7.4, at 0.4 ml/min according to Ship et al. (2005). Eluted fractions, collected at 1.5 min intervals, were added 5 ml of Ready Protein (Beckman Counter) and subjected to liquid scintillation spectrometry (model 5801, Beckman Coulter, Canada). The total radioactivity of each sample was also ascertained by liquid scintillation counting. The liver was homogenized (1:3 v/v with KHB) and centrifuged at 9000 g for 5 min, and an aliquot of the supernatant was subjected to liquid scintillation spectrometry, as previously described (Ship et al., 2005). A calibration curve was constructed by the addition of known dpm of radiolabeled hemoglobin to blank liver homogenate tissue (1:3 v/v with KHB);

the standards were processed in an identical manner as that for the liver samples. The calibration curve was used to relate to the total dpm recovered in liver samples.

Modeling

Compartmental Model. Perfusate concentrations (dpm/ml) of native and cross-linked human hemoglobins were normalized to the dose.

$$C = Ae^{-\alpha t} + Be^{-\beta t} \quad (1)$$

The above equation adequately described the disposition profile of intact hemoglobin. Since elimination is assumed to occur from the peripheral compartment only, the micro rate constants, k_{12} , k_{21} , and k_{20} in Equations 2 to 4, may be estimated from the coefficients and hybrid constants, α and β (Gibaldi and Perrier, 1982).

$$k_{12} = \frac{A\alpha + B\beta}{A + B} \quad (2)$$

$$k_{20} = \frac{\alpha\beta}{k_{12}} \quad (3)$$

$$k_{21} = \alpha + \beta - k_{12} - k_{20} \quad (4)$$

The “central” volume V_1 , is estimated as

$$V_1 = \frac{Dose}{(A + B)} \quad (5)$$

whereas the liver volume, V_2 , is estimated as

$$V_2 = V_1 \frac{k_{12}}{k_{21}} \quad (6)$$

with the assumption that the transfer clearances, V_1k_{12} and V_2k_{21} , are equal. The estimated volumes of distribution are then used to estimate influx (CL_{influx}) and metabolic intrinsic ($CL_{int,met}$) clearances.

DMD#19174

$$CL_{\text{influx}} = k_{12}V_1 \quad (7)$$

$$CL_{\text{int,met}} = k_{20}V_2 \quad (8)$$

Physiologically-Based Pharmacokinetic (PBPK) Model. A simple, physiologically-based pharmacokinetic model for a recirculating liver perfusion system is shown in Fig. 1B. The model comprises of three compartments: the reservoir (R); extracellular plasma (EC); and liver tissue (L). In this model, the flow rate (Q), and volumes (V_R , V_{EC} and V_L) are used. The transport clearances of the hemoglobin species across the sinusoidal membrane, from extracellular plasma to tissue and from tissue to extracellular plasma, are characterized by the influx (CL_{influx}) and efflux (CL_{efflux}) clearances that represent the summed transport of both haptoglobin-dependent and haptoglobin-independent pathways. Hemoglobin is metabolized by enzymes with a metabolic intrinsic clearance, $CL_{\text{int,met}}$, within the liver tissue.

Fitting

Fitting of the hemoglobin data in the reservoir to the compartment model (Fig. 1A) and PBPK model (Fig. 1B) was performed with Scientist® (Micromath, Saint Louis, MO). Appropriate weighting schemes (1, 1/observation, and 1/observation²) were used; the weighting of unity yielded the highest Model Selection Criterion and lowest coefficient of variation (standard deviation/parameter value).

Compartment Model. Eq. 1 was used to yield A, B, α and β for the two-compartment model (Fig. 1B). Fitting yielded the coefficients, A and B, and hybrid constants, α and β according to Eq. 1 (Gibaldi and Perrier, 1982). V_1 and V_2 , the volumes of distribution in reservoir and liver compartments, respectively, and k_{12} , k_{21} , k_{20} , CL_{influx} , and $CL_{\text{int,met}}$ were estimated from Eqs. 2 to 8.

DMD#19174

Physiological Model. Mass-balanced rate equations in the Appendix were used to yield CL_{influx} , CL_{efflux} , and $CL_{int,met}$ with the physiological model (Fig. 1B). The CL_{influx} and $CL_{int,met}$ derived from the compartment model were used as initial estimates. The extracellular plasma volume, sum of sinusoidal blood volume and sucrose Disse space, and value of the cellular water spaces (about 60% of liver weight) were obtained from Pang et al. (1988). First, data from each study was fitted individually, but this yielded very poor estimates due to the limited data and the large number of parameters that needed to be estimated. Hence, the aggregated data (all data within the same set of experiments) were used for each fit.

Data Analyses

Data were presented as mean \pm standard deviation. The two-tail student *t*-test was used to determine the significance among each hemoglobin species, with or without haptoglobin. The Wilcoxon Mann-Whitney Test and ANOVA were used to test differences of the means among data sets, native vs. cross linked hemoglobin when haptoglobin was present and absent. A *P* value of 0.05 was set as the level of statistical significance.

DMD#19174

RESULTS

Separation of Hemoglobins from Metabolites. Size-exclusion chromatography adequately separated the HBs (bound or unbound to Hp) that eluted between 20 to 40 min from the metabolites (from 40 min onwards) (Figs. 2 and 3). The nature of the radioactivity differed between perfusate and bile samples. Most of the dpms existed as intact HB in reservoir perfusate, and there were only minor amounts of HB metabolites present. The concentration of native human HB in reservoir perfusate [retention time, RT = 32 min] decreased over time (Fig. 2A). The same was observed for native human HB in the presence of rat plasma Hp (data not shown). By contrast, bile samples obtained from the hemoglobin studies, with and without plasma Hp, showed absence of intact, human HB or its bound complex (Fig. 2B). The majority of radioactivity in bile consisted of metabolite species of molecular weights that were much lower than those of HB and its Hp-bound complex. Likewise, cross-linked human HB was only found in reservoir perfusate and metabolite species were absent (Fig. 3A); the same was observed in cross-linked HB in the presence of rat plasma (data not shown). Again, the radioactivities in bile were mostly metabolites of cross-linked human HB (Fig. 3B); the same was observed in cross-linked HB in the presence of rat Hp (data not shown). Moreover, acellular native human and cross-linked human HB and their bound complexes exhibited virtually identical RT between 20 to 40 min in the chromatographic procedure.

Accumulation of Hemoglobin Metabolites into Bile and Liver. Radioactivity was observed in bile, usually after a short delay of about 10 min. Radioactivity, representing mostly metabolites of both native and cross-linked hemoglobins, was found excreted into bile (Fig. 4). Data resulting from dosing of the native human HB with added rat plasma Hp were associated with higher amounts of radioactivity in bile than when the dose was incubated with KHB (9.2 ± 2.1 vs. $7.1 \pm 1.6\%$ dose in 3 h), albeit the difference was not significant ($P > 0.05$). The

DMD#19174

radioactivity accumulated in bile ($7.2 \pm 0.8\%$ dose in 3 h) for cross-linked human HB in Hp-KHB was significantly higher than that incubated with KHB ($5.0 \pm 1.7\%$; $P < 0.05$) (Table 1). The amount of radioactivity in bile at 3 h found for the free-native human HB dose was higher than that for cross-linked human HB ($7.1 \pm 1.6\%$ vs. $5.0 \pm 1.7\%$; $P = 0.04$, Wilcoxon Mann-Whitney test). Moreover, a slightly longer delay in the biliary excretion/appearance of radioactivity in the first 30 min was observed for the studies of cross-linked human HB in KHB. The amounts of native human HB remaining in livers at 3 h, with or without rat Hp, were similar (5.8 to 6.1% dose; Table 1), whereas slightly higher values were observed for cross-linked human HB (7.6 to 8.3% dose, Table 1). The recovery of total radioactivity (summed amounts in perfusate, liver, and bile) was generally good, and accounted for 87% - 99% dose (Table 1).

Disappearance of the Hemoglobins from Perfusate. On average, unchanged native HB represented $> 95\%$ of the total radioactivity at each time point in studies in which KHB buffer or rat plasma was added to the hemoglobin doses. Thus, the total radioactivity in perfusate was used for estimation of the pharmacokinetic parameters. The decay patterns of unchanged HB in perfusate, normalized to the dose, were similar for the unbound form of native, human HB and that which had complexed with plasma Hp in 3 h perfusion studies (Fig. 5A). In both of the studies on free HB and Hp-bound HB, the distribution phase of the native HB was rapid and completed within 10 min; this was followed by a protracted decay. The patterns of disappearance of radioactivity of free and the Hp-bound cross-linked human HB in liver perfusion studies were similar; the unchanged cross-linked HB (free and Hp-bound) represented $> 95\%$ of the total radioactivity at each time point in studies in which buffer or rat plasma was added to the dose (Fig. 5B). The areas under the curves, AUCs, estimated by trapezoidal rule, were not significantly different, although the trend of a lower AUC being associated with rat plasma was observed for both human HB and cross-linked human HB studies (Table 1). Hepatic clearance

(CL) derived from dose/AUC, showed that the clearance of cross-linked human HB in the presence of Hp was less than that of human HB in the presence of Hp ($P < 0.05$, Wilcoxon Mann-Whitney test; Table 1).

Compartmental Modeling. The bi-exponential equation (Eq. 1) with a weighting scheme of unity adequately described the data of acellular native HB (Fig. 5A) and cross-linked HB (Fig. 5B) in presence and absence of Hp. The fit described a rapid initial decay during the first 10 min and a protracted elimination phase (Fig. 5). There was no significant difference in the fitted coefficients, A and B, for native or cross-linked HB, with and without added rat Hp (Table 2). Although α , the hybrid constant for the distribution phase, was smaller for the native hemoglobin compared to that of cross-linked hemoglobin, the difference was not significant due to the high variability. There was also difference for β , the hybrid constant for the elimination phase. The terminal half life for native HB tended to be shorter in comparison to that for cross-linked HB, and there was a tendency towards a shorter $t_{1/2}$ when Hp was present (Table 2); again these differences were not significant due to the high variability. Expectedly, the shorter half lives for native human HB were associated with lower AUCs and higher total body clearances (CL) compared to those for cross-linked HB. The AUCs, when estimated as $(A/\alpha + B/\beta)$, were similar to those from the trapezoidal rule (cf. Table 1). The AUCs were smaller and the CLs, higher, for each hemoglobin species when rat haptoglobin was present; but these differences were again not significant (Table 2). The livers cleared native human HB better than the cross-linked human HB, and values of clearance tended to be higher with Hp present. However, these CL values were not significantly different.

The intercompartmental rate constants (k_{12} and k_{21}) and elimination rate constant (k_{20}) were estimated from A, B, α and β with Equations 2 to 4, and V_1 and V_2 from Eqs. 5 and 6 for elimination from peripheral compartment only. These rate constants were converted to the influx

DMD#19174

clearance (CL_{influx} or $k_{12}V_1$) and the metabolic intrinsic clearance ($CL_{\text{int,met}}$ or $k_{20}V_2$). The influx clearances were slightly higher in the presence of Hp: values of CL_{influx} were 60% and 56% higher for native hemoglobin and cross-linked HB, although the difference was not significant (Table 2). By contrast, the CL_{influx} was significantly higher than the $CL_{\text{int,met}}$ ($P < 0.05$, Wilcoxin Mann-Whitney), and was 125-fold and 535-fold of $CL_{\text{int,met}}$ for native HB in absence and presence of Hp respectively. The CL_{influx} was 55-fold and 81-fold for cross-linked HB in absence and presence of Hp, respectively (Table 2). From this comparison, the much higher value for CL_{influx} over $CL_{\text{int,met}}$ suggests that uptake is much faster than elimination. The CL_{efflux} was not estimated from compartmental modeling since the inherent assumption of the bidirectional clearances being equal was not validated (Table 2).

Parameters for PBPK Model. As shown in Fig. 6, good fits were observed with the PBPK model (Fig. 1B). The fitted parameters are summarized in Table 3. A weighting factor of unity was shown to be optimal. Upon comparison, the value assigned to V_2 was noted to be similar to that estimated with the compartmental model (Table 2). When Hp was present, CL_{influx} was 4.7-fold higher for native HB and 2.4-fold higher for cross-linked HB. The influx clearance (CL_{influx}) was 2- to 3-fold greater than the efflux clearance (CL_{efflux}) (Table 3). No trend, however, was found among the data for $CL_{\text{int,met}}$. The ratios of $CL_{\text{influx}}/CL_{\text{int,met}}$ were 25 and 53 for native hemoglobin, in absence and presence of Hp, respectively, and were 24 and 70 for cross-linked human HB, in absence and presence of Hp, respectively (Table 3). These trends were similar to those projected from compartmental analyses (Table 2).

DMD#19174

DISCUSSION

The presence of specific HB-Hp receptors on liver parenchymal cells had led to the postulate that binding of HB to Hp promotes the internalization of HB into the liver (Bissell et al., 1972; Kino et al., 1980; Zuwala-Jagiello and Osada, 1998). Ship et al. (2005) had shown that, because acellular HB was almost completely bound to Hp in excess while binding of trimesyl-(Lys82) β -(Lys82) β cross-linked human HB was considerably lower (~30% bound), total body clearance of native human HB was indeed greater than that of cross-linked human HB in the rat *in vivo* (Ship et al., 2005) (Table 4). The observation was explained by the higher binding affinity of native human HB towards rat Hp (Lockhart and Smith, 1975; Ship et al., 2005). Similarly, absence of the vitamin D binding protein (DBP) for the binding of 25-hydroxyvitamin D₃ (25-OHD₃), an inactive metabolite of vitamin D, was found to alter the pharmacokinetics of 25-OHD₃ in mice (Safadi et al., 1999). The DBP-bound 25-OHD₃ complex interacted with the endocytic receptor, megalin, to facilitate reabsorption by endocytosis in the kidney (Nykjaer et al., 1999). These examples on protein-bound species promoting clearance contrasted those ordinarily observed for drugs. Normally, drug clearance is decreased with increased protein binding (Smallwood et al., 1988), unless saturation of protein binding occurred prior to saturation of the elimination process (Chiba and Pang, 1993). Due to the inhibitory nature of protein binding on clearance, bilirubin (Øie and Levy, 1975), tolbutamide (Scharly and Rowland, 1983), and diclofenac (Evans et al., 1993) exhibited decreased hepatic clearances when protein binding was increased.

The scenario of enhanced entry and therefore increased clearance for Hp-bound HB was expected to be evident in the present rat liver perfusion study, since the amount of native or cross-linked human HB administered was below the amount of Hp present to ensure maximal

binding of hemoglobin (Hershko et al., 1972). Results for this perfusion study were consistent with the hypothesis that haptoglobin binding increased hemoglobin entry. A rank order was found for CL_{influx} , the influx clearance that denotes entry of the hemoglobins into the liver: hemoglobin (+ haptoglobin) > free hemoglobin > cross-linked hemoglobin (+ haptoglobin) > free cross-linked hemoglobin with compartmental modeling (Table 2). A similar trend was found with the PBPK model, in which sinusoidal entry of the Hp-bound forms of native human HB and cross-linked human HB were >5-fold and >2-fold faster than those when Hp was absent (Table 3). The trend was more apparent with physiological modeling for which fewer assumptions were taken.

We anticipated that binding to Hp would trigger increased hepatic entry of HB (CL_{influx}) in the rat liver preparation and enhance clearance. The CL_{influx} for Hp-bound HB is 4.6x that of free HB, whereas that for Hp-bound cross-linked HB is 2.4x that of free cross linked HB (Table 3). Despite the higher CL_{influx} s for the Hp-bound hemoglobins, changes in clearance were modest (20 to 30%) (Table 1). A significant difference in clearance was found only between the Hp-bound forms of HB and cross-linked HB (Table 1), confirming previous results in vivo that a higher clearance existed for hemoglobin due to the higher binding to haptoglobin (Ship et al., 2005). A significant change in amounts excreted in bile at 3 h was found between cross-linked HB in absence and presence of Hp (Table 1); but no change was found for human hemoglobin. The total radioactivity recovered for native HB was higher than that for cross-linked HB, especially when Hp was present (Fig. 4, Table 1). The slightly improved biliary excretion of radioactivity, mostly as metabolites, failed to parallel the 2- to 5- fold change in CL_{influx} in the presence of Hp (Tables 1 and 3). Upon a closer perusal, we noted that CL_{influx} was much greater than the metabolic intrinsic clearance ($CL_{int,met}$) in both physiological and compartmental modeling (Tables 2 and 3), suggesting that $CL_{int,met}$ is the rate-limiting step in clearance. The

DMD#19174

trends for CL_{influx} and $CL_{int,met}$ were similar for both compartmental and physiological modeling (Tables 2 and 3), suggesting that while the Hp played an important role in the entry of HB into liver, metabolism of hemoglobin in the liver remains as the rate limiting step. Even without Hp present, the CL_{influx} of native and cross-linked hemoglobin is still at least 23 fold greater than that of the $CL_{int,met}$. Thus, Hp, expected to enhance the entry of native and cross-linked human hemoglobin by increasing CL_{influx} , exerts only a blunted impact since CL of HB is limited by metabolism and not influx.

Similarities were found between the present data and observations *in vivo* (Table 4). In both the rat *in vivo* and perfused liver preparation, only unchanged HB was found in the blood/perfusate, whereas only small molecular weight metabolites were found in liver/bile (Figs. 2 and 3), as confirmed by others (Takami, 1993). Differences were also found. Values of hepatic CL (0.0109 and 0.0061 $ml \cdot min^{-1} \cdot g^{-1}$ for the Hp-bound HB or cross-linked HB) from the perfusion study (Table 1) were only 30-50% of the total CL found *in vivo* (Ship et al., 2005). Clearing organs other than the liver are likely involved in the removal of the hemoglobins *in vivo*. The hepatic clearance is likely lower in the KHB-perfused liver since other tissues that contain the macrophages are absent. The chosen volume for perfusion (150 ml) was significantly larger than those expected for the liver *in vivo* (12 ml and 6 ml for native human HB and cross-linked human HB, respectively); the larger volume in the perfusion system constituted artificially higher $t_{1/2S}$ (Table 4). In contrast to the monoexponential decay (instantaneous distribution) observed following the intravenous injection of native human and cross-linked human hemoglobins in the rat *in vivo* (Ship et al., 2005), a sharp distribution phase followed by a prolonged, elimination phase was observed in the rat liver preparations (Fig. 5). The bi-exponential characteristics suggest that there are at least two compartments, a central and a peripheral (liver) compartment (Fig. 1). Inasmuch as observations for the isolated preparation

DMD#19174

reflected strictly events occurring in the liver, there appeared to be increased sensitivity in the system to reveal the distribution phase in liver, a process which was likely masked or obscured by the presence of multiple organs *in vivo*.

In summary, native and cross-linked human hemoglobins both showed similar bi-exponential decay profiles in the perfused rat liver preparation. Perfusate contained mostly unchanged hemoglobin, and bile, low molecular weight metabolites; these were also observed *in vivo*. However, a distribution phase was further revealed in liver perfusion studies. A substantial influx was found for both native and cross-linked human hemoglobins in absence of Hp (Tables 2 and 3). Upon fitting to the open, two-compartment model and to the PBPK model, the influx clearance, CL_{influx} , was found to be much faster in the presence of Hp, and greatly exceeded the metabolic intrinsic clearance, $CL_{int,met}$. For this reason, changes in CL_{influx} with Hp failed to directly impact the clearance of the hemoglobins as had previously envisioned, despite that the trend of enhanced hemoglobin entry due to binding to rat haptoglobin was observed. The hypothesis that haptoglobin binding to hemoglobin enhanced entry was correct. However, the improved entry failed to strongly influence the clearance since degradation of the hemoglobin was rate-determining. Hence, the kinetic analyses resulting from this liver perfusion study lend direct insight as to entry of the free vs. the bound forms of native and cross-linked hemoglobins, and the rate-limiting step in hepatic removal of the hemoglobins. This process for the native human and cross-linked human hemoglobins is metabolism within the rat liver and not entry.

References

- Bissell DM, Hammaker L, and Schmid R (1972) Hemoglobin and erythrocyte catabolism in rat liver: the separate roles of parenchymal and sinusoidal cells. *Blood* **40**:812-822.
- Bunn HF (1967) Effect of sulfhydryl reagents on the binding of human hemoglobin to haptoglobin. *J Lab Clin Med* **70**:606-618.
- Bunn HF, Esham WT, and Bull RW (1969) Renal handling of hemoglobin. I. Glomerular filtration. *J Exp Med* **129**:909-924.
- Chang TM (1999) Future prospects for artificial blood. *Trends Biotechnol* **17**:61-67.
- Chiba M and Pang KS (1993). Effect of protein binding on 4-methylumbelliferyl sulfate desulfation kinetics in perfused rat liver. *J Pharmacol Exp Ther* **266**:492-499.
- Clarke DJ, Moghrabi N, Monaghan G, Cassidy A, Boxer M, Hume R, and Burchell B (1997) Genetic defects of the UDP-glucuronosyltransferase-1 (UGT1) gene that cause familial non-haemolytic unconjugated hyperbilirubinaemias. *Clin Chim Acta* **266**:63-74.
- Creteur J and Vincent JL (2003) Hemoglobin solutions. *Crit Care Med* **31**:S698-S707.
- Evans AM, Hussein Z, and Rowland M (1993) Influence of albumin on the distribution and elimination kinetics of diclofenac in the isolated perfused rat liver: analysis by the impulse-response technique and the dispersion model. *J Pharm Sci* **82**:421-428.
- Gburek J, Verroust PJ, Willnow TE, Fyfe JC, Nowacki W, Jacobsen C, Moestrup SK, and Christensen EI (2002) Megalin and cubilin are endocytic receptors involved in renal clearance of hemoglobin. *J Am Soc Nephrol* **13**:423-430.
- Gibaldi M and Perrier D (1982) In “*Pharmacokinetics*” 2nd Edition, Marcel Dekker, NY.
- Goldfischer S, Novikoff AB, Albala A, and Biempica L (1970) Hemoglobin uptake by rat hepatocytes and its breakdown within lysosomes. *J Cell Biol* **44**:513-529.
- Graversen JH, Madsen M, and Moestrup SK (2002) CD163: a signal receptor scavenging haptoglobin-hemoglobin complexes from plasma. *Int J Biochem Cell Biol* **34**:309-314.

DMD#19174

- Greer J, Liao WD, and Brown WE (1981) Haptoglobin-hemoglobin complex. Subunit interaction probed by cross-linking. *J Biol Chem* **256**:8771-8774.
- Hershko C, Cook JD, and Finch CA (1972) Storage iron kinetics. II. The uptake of hemoglobin iron by hepatic parenchymal cells. *J Lab Clin Med* **80**:624-634.
- Higa Y, Oshiro S, Kino K, Tsunoo H, and Nakajima H (1981) Catabolism of globin-haptoglobin in liver cells after intravenous administration of hemoglobin-haptoglobin to rats. *J Biol Chem* **256**:12322-12328.
- Huang MJ, Kua KE, Teng HC, Tang KS, Weng HW, and Huang CS (2004) Risk factors for severe hyperbilirubinemia in neonates. *Pediatr Res* **56**:682-689.
- Keene WR and Jandl JH (1965) The sites of hemoglobin catabolism. *Blood* **26**: 705–719.
- Kluger R, Song Y, Wodzinska J, Head C, Fujita TS, and Jones RT (1992) Trimesoyl tris(3,5-dibromosalicylate): specificity of reactions of a trifunctional acylating agent with hemoglobin. *J Am Chem Soc* **114**: 9275–9279.
- Kino K, Mizumoto K, Watanabe J, and Tsunoo H (1987) Immunohistochemical studies on hemoglobin-haptoglobin and hemoglobin catabolism sites. *J Histochem Cytochem* **35**:381-386.
- Kino K, Tsunoo H, Higa Y, Takami M, Hamaguchi H, and Nakajima H (1980) Hemoglobin-haptoglobin receptor in rat liver plasma membrane. *J Biol Chem* **255**:9616-9620.
- Lim SK, Kim H, Lim SK, bin Ali A, Lim YK, Wang Y, Chong SM, Costantini F, and Baumman H (1998) Increased susceptibility in Hp knockout mice during acute hemolysis. *Blood* **92**:1870-1877.
- Lockhart WL and Smith DB (1975) Cross-linking of hemoglobin, haptoglobin, and hemoglobin-haptoglobin complex with bifunctional imidoesters. *Can J Biochem* **53**:861-867.
- McCormick DJ and Atassi MZ (1990) Hemoglobin binding with haptoglobin: delineation of the haptoglobin binding site on the alpha-chain of human hemoglobin. *J Protein Chem* **9**:735-742.

- Nykjaer A, Dragun D, Walther D, Vorum H, Jacobsen C, Herz J, Melsen F, Christensen EI, and Willnow TE (1999) An endocytic pathway essential for renal uptake and activation of the steroid 25-(OH) vitamin D₃. *Cell* **96**:507-515.
- Øie S, Levy G (1975). Effect of plasma protein binding on elimination of bilirubin. *J Pharm Sci* **64**:1433
- Palaparthi R, Kastrissios H, and Gulati A (2001) Pharmacokinetics of diaspirin cross-linked haemoglobin in a rat model of hepatic cirrhosis. *J Pharm Pharmacol* **53**:179-185.
- Pang KS, Lee WF, Cherry WF, Yuen V, Accaputo J, Fayz S, Schwab AJ, Goresky CA (1988) Effects of perfusate flow rate on measured blood volume, disse space, intracellular water space, and drug extraction in the perfused rat liver preparation: characterization by the multiple indicator dilution technique. *J Pharmacokinet Biopharm* **16**:595-632.
- Polfliet MM, Fabriek BO, Daniëls WP, Dijkstra CD, and van den Berg TK (2006) The rat macrophage scavenger CD163: expression, regulation, and role in inflammatory mediator production. *Immunology* **211**:419-425.
- Putnam FW (1976) The trace components of plasma: an overview. *Prog Clin Biol Res* **5**:1-24.
- Roach TA, Macdonald VW, and Hosmane RS (2004) A novel site-directed affinity reagent for cross-linking human hemoglobin: bis[2-(4-phosphonooxyphenoxy) carbonylethyl]-phosphinic acid. *J Med Chem* **47**:5847-5859.
- Safadi FF, Thornton P, Magiera H, Hollis BW, Gentile M, Haddad JG, Liebhaber SA, Cooke NE (1999) Osteopathy and resistance to vitamin D toxicity in mice null for vitamin D binding protein. *J Clin Invest* **103**:239-251.
- Schary WL and Rowland M (1983) Protein binding and hepatic clearance: studies with tolbutamide, a drug of low intrinsic clearance, in the isolated perfused rat liver preparation. *J Pharmacokinet Biopharm* **11**:225-43.
- Smallwood RH, Mihaly GW, Smallwood RA, and Morgan DL (1988) Effect of a protein binding change on unbound and total plasma concentrations for drugs of intermediate hepatic extraction. *J Pharmacokinet Biopharm* **16**:529-542.

DMD#19174

Ship NJ, Toprak A, Lai RP, Tseng E, Kluger R, and Pang KS (2005) Binding of acellular, native and cross-linked human hemoglobins to haptoglobin: enhanced distribution and clearance in the rat. *Am J Physiol* **288**:G1301-G1309.

Takami M (1993) Catabolism of heme moiety of hemoglobin-haptoglobin in rat liver cells in vivo. *J Biol Chem* **268**:20335-20342.

Tirona RG, Tan E, Meier G, and Pang KS (1999) Uptake and glutathione conjugation kinetics of ethacrynic acid in rat liver: *in vitro* and perfusion studies. *J Pharmacol Exp Ther* **291**:1210-1219.

Voet D and Voet JG (1995) "Biochemistry" 2nd edition, New York: Wiley.

Weinstein MB and Segal HL (1984) Uptake of free hemoglobin by rat liver parenchymal cells. *Biochem Biophys Res Commun* **123**:489-496.

Winslow RM (1992) "Hemoglobin-Based Red Cell Substitutes" Baltimore, MD: Johns Hopkins University Press.

Zuwala-Jagiello J and Osada J (1998) Internalization study using EDTA-prepared hepatocytes for receptor-mediated endocytosis of haemoglobin-haptoglobin complex. *Int J Biochem Cell Biol* **30**:923-931.

DMD#19174

Footnotes Page

¹Present Address: Genentech Inc., 1 DNA Way, MS 412A, South San Francisco, CA 94080-4990

This work was supported by grants from the National Sciences and Engineering Research Council of Canada (NSERC), a Strategic (234768-00) Project and a Collaborative Health Research Program (237960-00) Grant to K.S.P. and R.H.K..

Legends for Figures

- Fig. 1. **Modeling approaches.** (A) A two-compartment model with elimination from the peripheral compartment (elimination rate constant k_{20}) was used; the transfer rate constants between the compartments are denoted by k_{12} and k_{21} , respectively. (B) A physiologically-based pharmacokinetic (PBPK) model consisting of the reservoir compartment (of volume V_R and concentration C_R) and extracellular compartment (of volume V_{EC} and concentration C_{EC}) that are interconnected by flow, Q , was used. Entry and exit of hemoglobin into and out of the liver compartment (of volume V_L and concentration C_L) and the EC space occur with influx (CL_{influx}) and efflux (CL_{efflux}) clearances, respectively. Hemoglobin is metabolized by the liver with metabolic intrinsic clearance, $CL_{int,met}$.
- Fig. 2. **Size-exclusion chromatography of acellular, [3H]-labeled native human hemoglobin in reservoir perfusate (A), and [3H]-labeled metabolites in bile (B), when KHB was preincubated with the dose.** For bile, only the data for 0, 30, 60, 120, and 180 min were shown. Similar results were obtained when rat plasma was preincubated with the dose of [3H]labeled native human hemoglobin.
- Fig. 3. **Size-exclusion chromatography of acellular, [3H]-labeled cross-linked human hemoglobin in reservoir perfusate (A), and [3H]-labeled metabolites in bile (B), when KHB was preincubated with the dose.** For bile, only the data for 0, 30, 60, 120, and 180 min were shown. Similar results were obtained when rat plasma was preincubated with the dose of [3H]labeled cross-linked human hemoglobin.
- Fig. 4. **Biliary excretion.** Accumulation of total radioactivities (hemoglobin metabolites in bile when doses of [3H]native human hemoglobin (A) and [3H]cross-linked human hemoglobin (B), preincubated with KHB or rat haptoglobin; the data shown were for 3 h of rat liver perfusion. “*” denotes $P < 0.05$, data in KHB dose vs. data in rat plasma dose.
- Fig. 5. **Compartmental analyses.** Fitting of the perfusate data of intact hemoglobin obtained upon recirculation of (A) [3H]native human hemoglobin and (B) [3H]cross-linked human hemoglobin doses in KHB and rat plasma to the two-compartment model. The lines represent the best fit to the data.
- Fig. 6. **Physiological modeling.** Fitting of the perfusate data of intact hemoglobin obtained upon recirculation of (A) [3H]native human hemoglobin and (B) [3H]cross-linked human hemoglobin doses in KHB and rat plasma to the physiologically based pharmacokinetic model. The lines represent the best fit to the data.

Table 1. Model-independent data associated with (^3H -acetylated) native human and cross-linked, human hemoglobin doses in the presence or absence of rat plasma (haptoglobin) in rat liver perfusion studies^a

	Liver Weight (g)	Amount in Perfusate ^b (%dose)	Amount in Liver (%dose)	Amount in Bile (%dose)	Total Amount ^c (%dose)	AUC _(0→∞) ^d (min/ml)	CL ^e (ml·min ⁻¹ ·g ⁻¹)
Native Hemoglobin (n = 4)	11.5 ± 1.7	77.2 ± 5.2	5.8 ± 0.6	7.1 ± 1.6	90.3 ± 6.0	1090 ± 195	0.0084 ± 0.0024
Native Hemoglobin + Rat Plasma (n = 3)	12.1 ± 1.4	77.7 ± 2.9	6.1 ± 1.3	9.2 ± 2.1	86.9 ± 5.0	846 ± 299	0.0109 ± 0.0043
Cross-linked Hemoglobin (n = 4)	12.7 ± 1.1	84.5 ± 2.7	8.3 ± 2.1	5.0 ± 1.7 [*]	97.5 ± 2.8	1900 ± 902	0.0049 ± 0.0021
Cross-Linked Hemoglobin + Rat Plasma (n = 4)	12.4 ± 0.6	83.8 ± 6.8	7.6 ± 1.2	7.2 ± 0.8 [†]	98.5 ± 7.6 [#]	1380 ± 366	0.0061 ± 0.0014 ^{**}

^a mean ± SD

^b perfusate concentration × reservoir volume/dose

^c sum of amounts in perfusate, liver, and bile

^d AUC_(0→∞) was calculated by the trapezoidal rule method: AUC_(0→180 min) + AUC, extrapolated to infinity or (C_(180 min)/β) where β is the terminal, decay constant

^e Clearance (CL) was calculated as dose/trapezoidal AUC_(0→∞)

^{*} $P = 0.043$, vs. native hemoglobin, Wilcoxon Mann-Whitney test

^{**} $P < 0.05$, vs. native hemoglobin + rat plasma, Wilcoxon Mann-Whitney test

[†] $P < 0.05$; vs. cross-linked hemoglobin, student t test

[#] $P < 0.05$; vs. native hemoglobin + rat plasma, student t test

Table 2. Pharmacokinetic parameters of total native human (^3H -acetylated) and cross-linked (^3H -acetylated) human hemoglobin, based on compartmental analyses, in the presence or absence of rat plasma (haptoglobin)

	Native Hemoglobin (n = 4)	Native Hemoglobin + Rat Plasma (n = 3)	Cross-linked Hemoglobin (n = 4)	Cross-Linked Hemoglobin + Rat Plasma (n = 4)
A (%dose/ml)	0.087 ± 0.023	0.094 ± 0.050	0.088 ± 0.020	0.108 ± 0.019
B (%dose/ml)	0.58 ± 0.03	0.52 ± 0.07	0.58 ± 0.02	0.56 ± 0.02
A (%dose)	13.0 ± 3.48	15.0 ± 6.39	13.2 ± 3.05	16.3 ± 2.80
B (%dose)	86.4 ± 3.99	85.1 ± 6.44	86.9 ± 3.26	83.9 ± 3.33
α (min^{-1})	0.61 ± 0.81	0.82 ± 0.53	0.26 ± 0.13	0.36 ± 0.32
β (min^{-1})	0.00067 ± 0.00026	0.00062 ± 0.00042	0.00062 ± 0.00015	0.00056 ± 0.00004
$t_{1/2,\beta}$ (min)	1150 ± 390	957 ± 261	1750 ± 1214	1240 ± 85
k_{12}^a (min^{-1})	0.086 ± 0.113	0.136 ± 0.1038	0.034 ± 0.029	0.054 ± 0.039
k_{21}^a (min^{-1})	0.518 ± 0.703	0.675 ± 0.443	0.207 ± 0.130	0.304 ± 0.281
k_{20}^a (min^{-1})	0.0052 ± 0.0023	0.0052 ± 0.0041	0.0052 ± 0.0021	0.0035 ± 0.0007
V_1^b (ml)	151 ± 1.95	167 ± 28.74	150 ± 1.01	150 ± 1.23
V_2^c (ml)	29.6 ± 11.41	24.5 ± 6.70	22.8 ± 5.99	30.1 ± 6.64
$\text{AUC}_{(0 \rightarrow \infty)}^d$ (min/ml)	916 ± 371	689 ± 29	1840 ± 737	991 ± 82
CL^e ($\text{ml} \cdot \text{min}^{-1} \cdot \text{g}^{-1}$)	0.009 ± 0.002	0.010 ± 0.003	0.0065 ± 0.0032	0.0080 ± 0.0004
$\text{CL}_{\text{influx}}$ or $k_{12}V_1$ ($\text{ml} \cdot \text{min}^{-1} \cdot \text{g}^{-1}$)	1.15 ± 1.62	1.81 ± 1.54	0.41 ± 0.38	0.64 ± 0.47
$\text{CL}_{\text{int,met}}$ or $k_{20}V_2$ ($\text{ml} \cdot \text{min}^{-1} \cdot \text{g}^{-1}$)	0.0104 ± 0.0028 [#]	0.0098 ± 0.0068 [#]	0.0084 ± 0.0014 [#]	0.0081 ± 0.0004 ^{*,#}
$\text{CL}_{\text{influx}}/\text{CL}_{\text{int,met}}$	125 ± 192	535 ± 782	54.8 ± 58.6	81.3 ± 63.4

^a Micro rate constants pertaining to the distribution (k_{12} and k_{21}) and elimination (k_{20})

^b V_1 was estimated from Eq. 5

^c V_2 was estimated from Eq. 6

^d $\text{AUC}_{(0 \rightarrow \infty)}$ was calculated as $A/\alpha + B/\beta$

^e Clearance (CL) as $\text{dose}/(A/\alpha + B/\beta)$

* $P < 0.05$, vs. $\text{CL}_{\text{influx}}$ of cross-linked human hemoglobin + rat plasma, Student t -test

[#] significantly different from $\text{CL}_{\text{influx}}$, $P < 0.05$ Wilcoxon Mann-Whitney test

Table 3. Parameters for native human ($[^3\text{H}]$ acetylated) and cross-linked ($[^3\text{H}]$ acetylated) human hemoglobin in the presence or absence of rat plasma (haptoglobin) based on the physiologically based pharmacokinetic (PBPK) model^a

	Native Hemoglobin	Native Hemoglobin + Rat Plasma	Cross-linked Hemoglobin	Cross-Linked Hemoglobin + Rat Plasma
$Q^{a,b}$ (ml/min)	40, 40, 40, 40	35, 40, 40	39, 40, 40, 40	35, 40, 40, 40
V_R (ml)	150	150	150	150
$V_{EC}^{a,c}$ (ml)	15.1, 14.2, 14.5, 14.3	13.2, 14.3, 14.9	14.2, 15.0, 14.9, 14.7	13.1, 14.7, 14.7, 15.0
$V_L^{a,d}$ (ml)	8.4, 6.1, 6.8, 6.3	7.5, 6.3, 7.9	6.9, 8.2, 8.0, 7.2	7.2, 7.5, 7.4, 8.1
CL_{influx} (ml·min ⁻¹ ·g ⁻¹)	0.052 ± 0.024	0.24 ± 0.20	0.040 ± 0.020	0.095 ± 0.032
CL_{efflux} (ml·min ⁻¹ ·g ⁻¹)	0.021 ± 0.018	0.11 ± 0.11	0.020 ± 0.019	0.034 ± 0.017
$CL_{int,met}$ (ml·min ⁻¹ ·g ⁻¹)	0.0020 ± 0.0033	0.0047 ± 0.0028	0.0017 ± 0.0036	0.0013 ± 0.0014
$CL_{influx} / CL_{int,met}$	25.6	52.6	23.4	71.1

^a The aggregate data from all experiments of the same study set were used in the fit; otherwise the data fit was poor

^b actually flow rates for each study

^c Sum of sinusoidal blood volume + sucrose Disse space, taken from Pang et al. (1988), multiplied by the weight of the liver

^d Calculated as 60% of liver weight, from Pang et al. (1988)

Table 4. Comparison of total hepatic clearance, volumes and $t_{1/2}$ s from the liver perfusion studies and those *in vivo* (from Ship et al., 2005)

	Present Perfusion Study (with rat plasma)			Data of Ship et. al. (2005)			Ratio (perfusion/ <i>in vivo</i>)		
	CL_{liver} (ml.min.g ⁻¹ liver)	$V_{\text{perfusion}}$ (ml)	$t_{1/2}$ (mn)	$CL_{\text{in vivo}}$ (ml.min.g ⁻¹) ^a	$V_{\text{in vivo}}$ (ml/kg)	$t_{1/2}$ (mn)	CL_{liver}	Volume	$t_{1/2}$
Native hemoglobin	0.0109	150	957	0.0366	39-40 (12) ^a	22-23	0.30	12.5	43.5
Cross-linked hemoglobin	0.0061	150	1240	0.012	9-20 (6) ^a	33-37	0.51	25	38

^a value within bracket is volume (ml) for a 300 g rat with a 10 g liver

Fig. 1

(A)

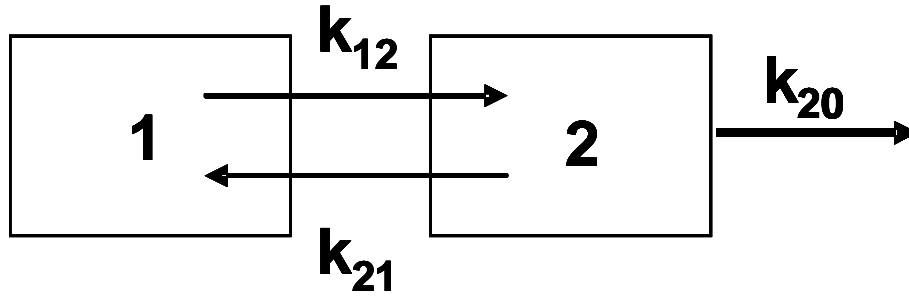

(B)

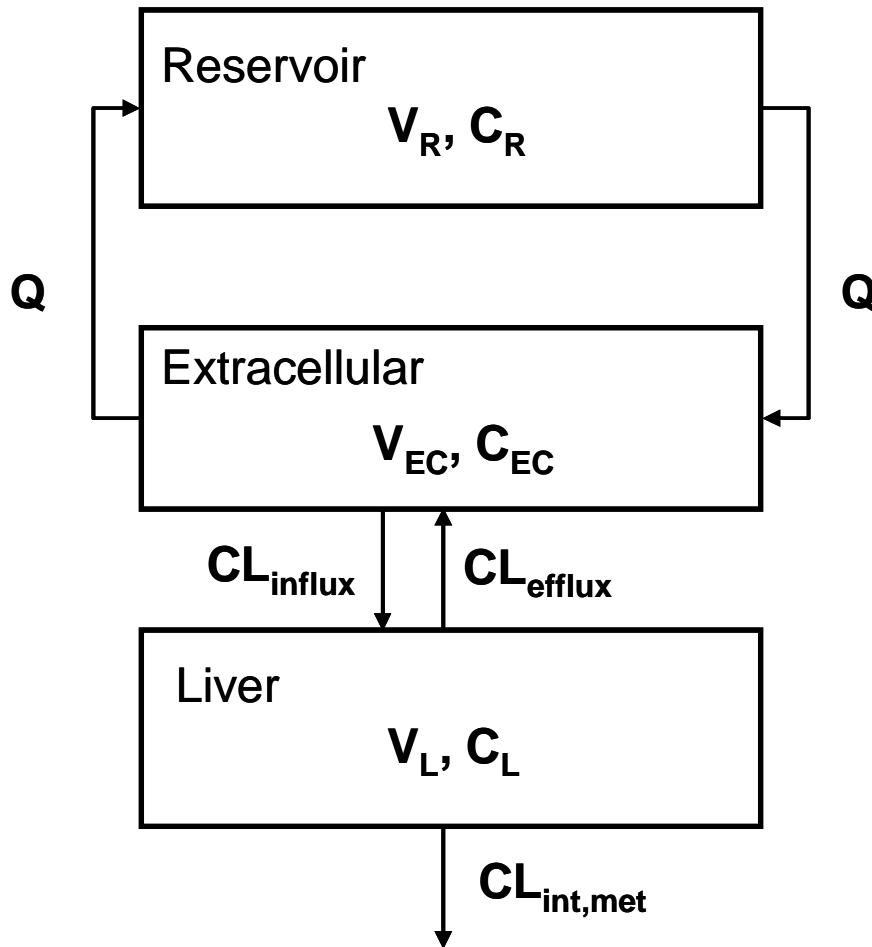
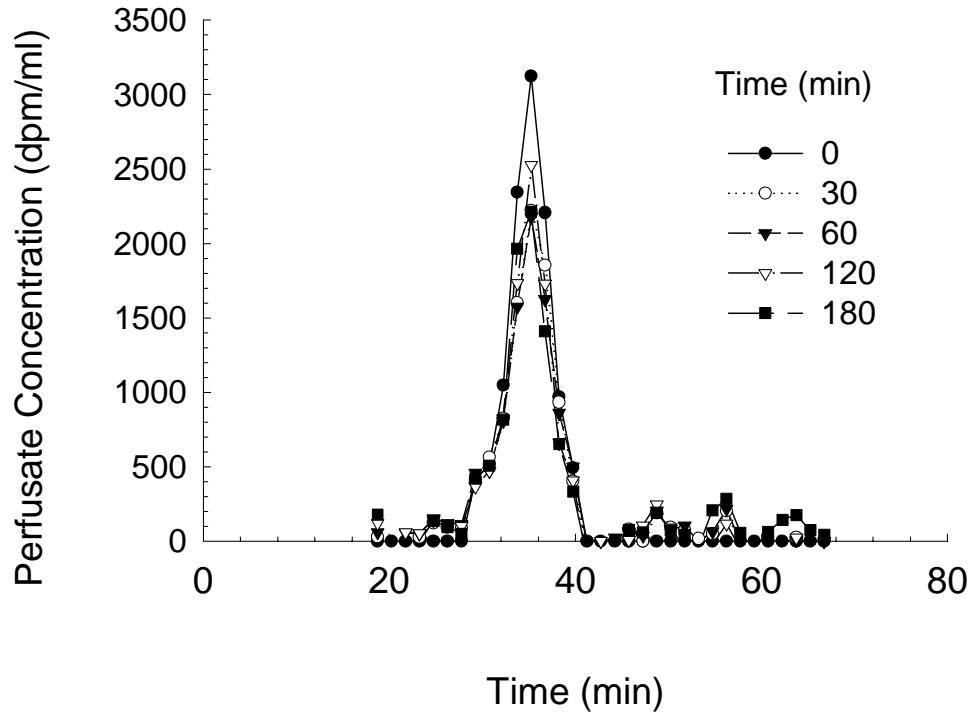

Fig. 2

(A)



(B)

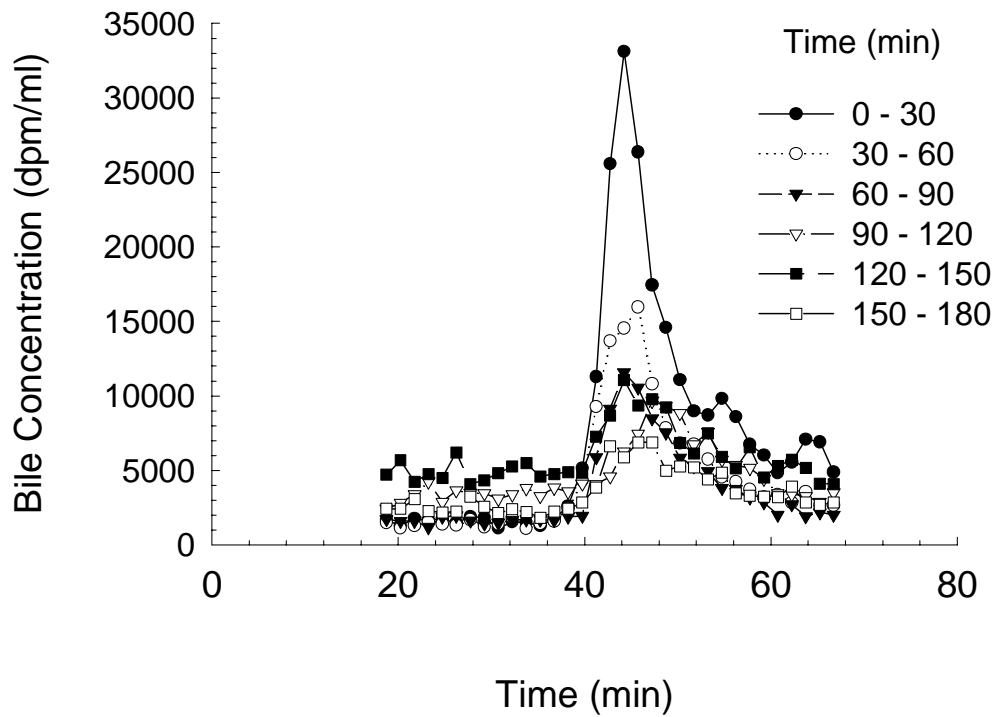
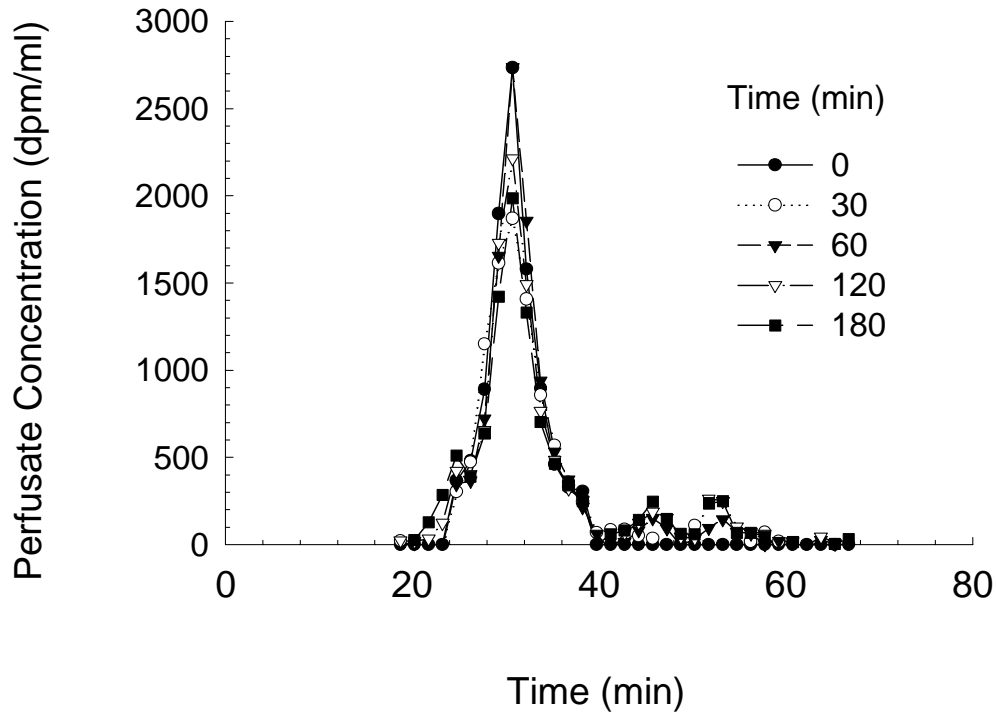

Fig. 3

(A)



(B)

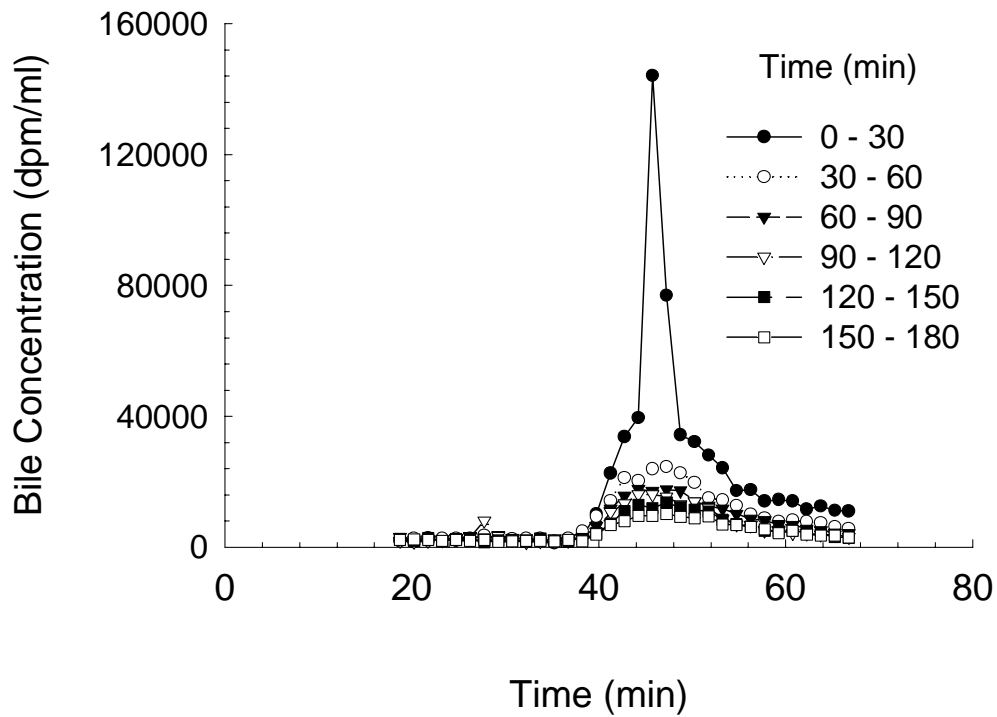
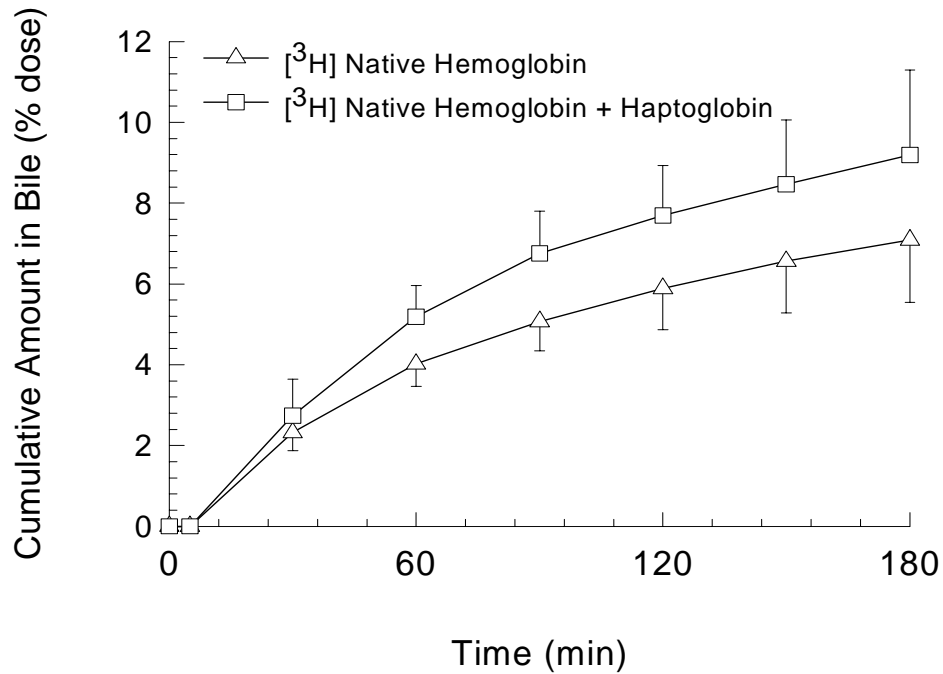

Fig. 4

(A)



(B)

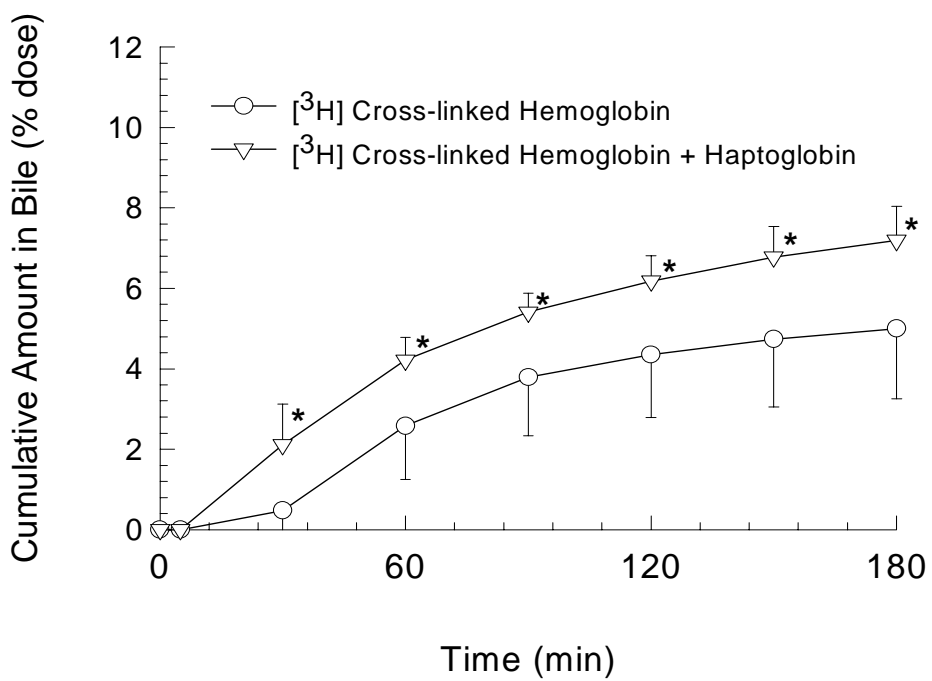
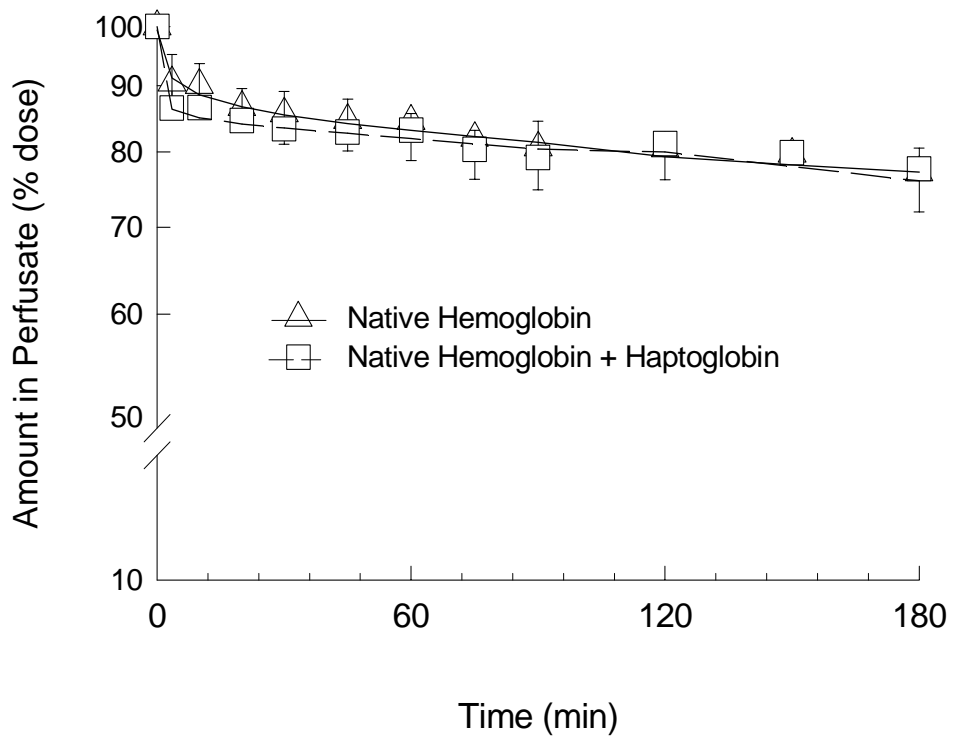

Fig. 5

(A)



(B)

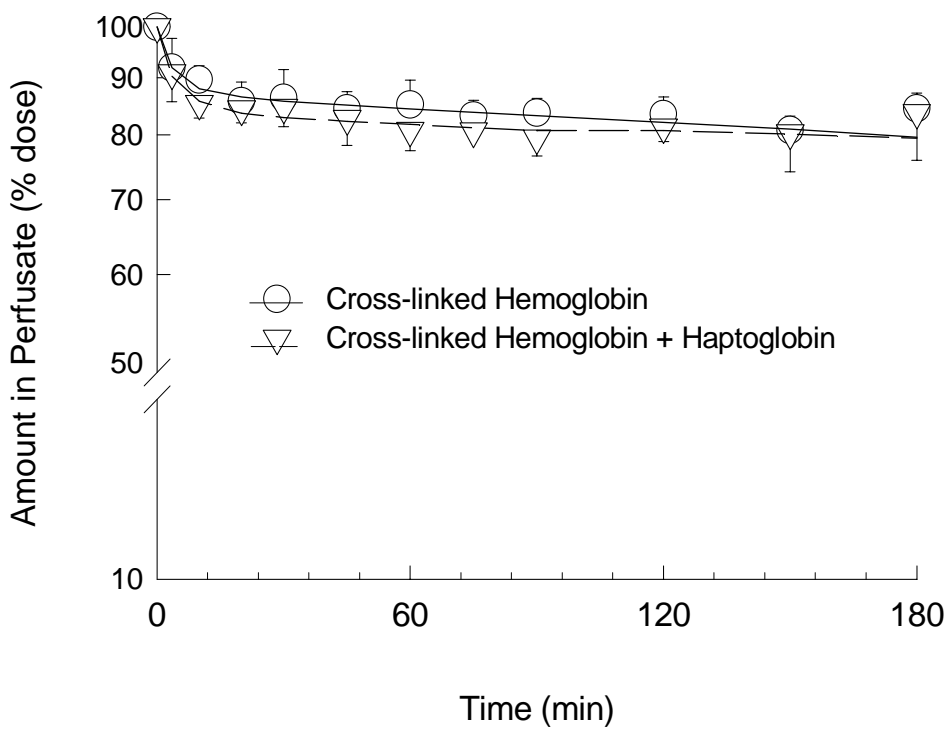
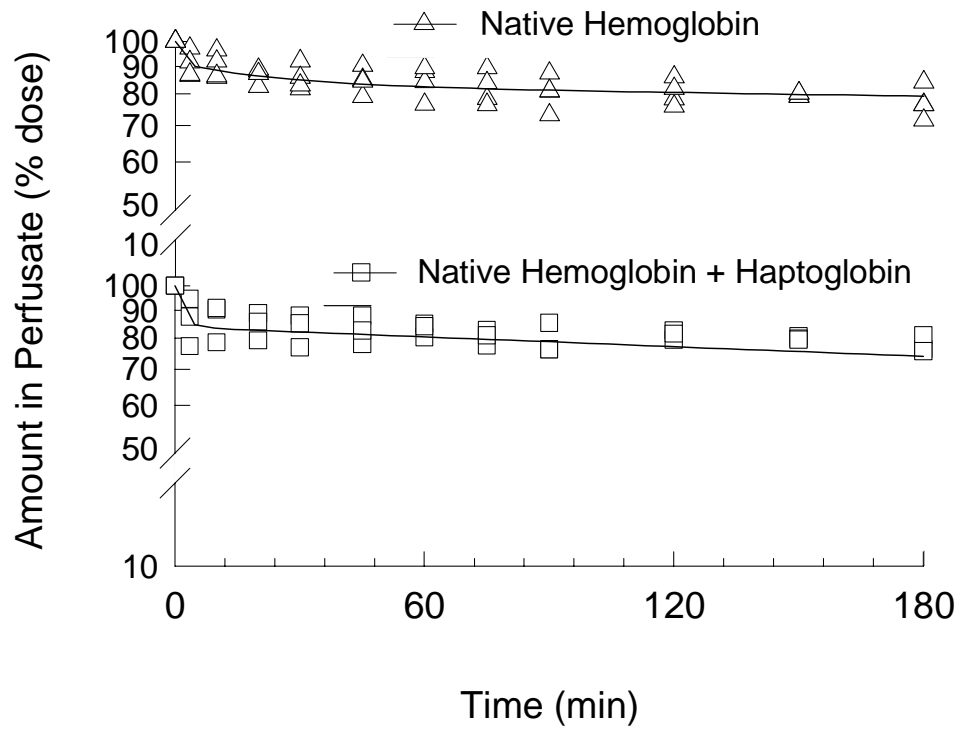
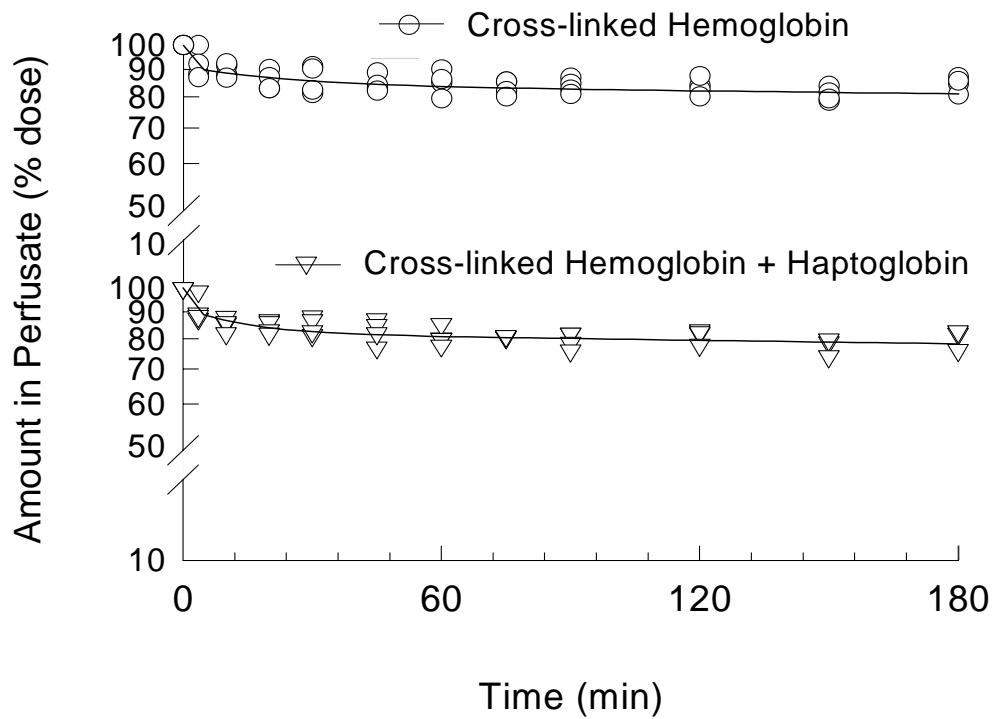

Fig. 6

(A)



(B)



APPENDIX

Mass balance rate equations for Liver as the only eliminating organ.

The following are first order rate equations that describe the rate of change of hemoglobin species in the reservoir (R), the extracellular plasma space (EC), and in the liver (L)

For rate of change in reservoir (R)

$$\frac{dC_R}{dt} = Q \frac{(C_{EC} - C_R)}{V_R} \quad (A1)$$

For rate of change in extracellular plasma

$$\frac{dC_{EC}}{dt} = \frac{Q(C_R - C_{EC}) + CL_{efflux}C_L - CL_{influx}C_{EC}}{V_{EC}} \quad (A2)$$

For rate of change in liver

$$\frac{dC_L}{dt} = \frac{CL_{influx}C_{EC} - CL_{efflux}C_L - CL_{int,met}C_L}{V_L} \quad (A3)$$